



LCD Monitor

User Manual

Regulatory Information

FCC Information

Please take attention that changes or modification not expressly approved by the party responsible for compliance could void the user's authority to operate the equipment.

FCC compliance: This equipment has been tested and found to comply with the limits for a Class A digital device, pursuant to part 15 of the FCC Rules. These limits are designed to provide reasonable protection against harmful interference when the equipment is operated in a commercial environment. This equipment generates, uses, and can radiate radio frequency energy and, if not installed and used in accordance with the instruction manual, may cause harmful interference to radio communications. Operation of this equipment in a residential area is likely to cause harmful interference in which case the user will be required to correct the interference at his own expense.

FCC Conditions

This device complies with part 15 of the FCC Rules. Operation is subject to the following two conditions:

1. This device may not cause harmful interference.
2. This device must accept any interference received, including interference that may cause undesired operation.

EU Conformity Statement

 This product and - if applicable - the supplied accessories too are marked with "CE" and comply therefore with the applicable harmonized European standards listed under the EMC Directive 2014/30/EU, the LVD Directive 2014/35/EU, the RoHS Directive 2011/65/EU.

 2012/19/EU (WEEE directive): Products marked with this symbol cannot be disposed of as unsorted municipal waste in the European Union. For proper recycling, return this product to your local supplier upon the purchase of equivalent new equipment, or dispose of it at designated collection points. For more information see: www.recyclethis.info

 2006/66/EC (battery directive): This product contains a battery that cannot be disposed of as unsorted municipal waste in the European Union. See the product documentation for specific battery information. The battery is marked with this symbol, which may include lettering to indicate cadmium (Cd), lead (Pb), or mercury (Hg). For proper recycling, return the battery to your supplier or to a designated collection point. For more information see: www.recyclethis.info

Industry Canada ICES-003 Compliance

This device meets the CAN ICES-3 (A)/NMB-3(A) standards requirements.

 **WARNING**



To prevent injury, this apparatus must be securely attached to the floor/wall in accordance with the installation instructions.

Applicable Models

This manual is applicable to the model: DS-D5043UC/DS-D5055UC/DS-D5065UC.

Symbol Conventions

The symbols that may be found in this document are defined as follows.

Symbol	Description
 NOTE	Provides additional information to emphasize or supplement important points of the main text.
 WARNING	Indicates a potentially hazardous situation, which if not avoided, could result in equipment damage, data loss, performance degradation, or unexpected results.
 DANGER	Indicates a hazard with a high level of risk, which if not avoided, will result in death or serious injury.

This is a class A product and may cause radio interference in which case the user may be required to take adequate measures.

WARNING: This equipment is compliant with Class A of EN55032/CISPR 32. In a residential environment this equipment may cause radio interference.

Contents

1.	Safety instructions	1
1.1.	Screen maintenance	3
2.	Parts and Functions.....	4
2.1.	Button Description	4
2.1.1.	DS-D5043UC	4
2.1.2.	DS-D5055UC	4
2.1.3.	DS-D5065UC	5
2.2.	Input/Output Terminals	6
2.2.1.	DS-D5043UC	6
2.2.2.	DS-D5055UC	6
2.2.3.	DS-D5065UC	7
2.3.	Remote control	8
2.3.1.	General function	8
2.3.2.	Inserting the batteries in the remote control	9
2.3.3.	Handling the remote control.....	9
2.3.4.	Remote control use	9
3.	Connecting External Equipment	10
3.1.	Connecting External Equipment.....	10
3.1.1.	Using HDMI video input	10
3.2.	Connecting a PC.....	10
3.2.1.	Using HDMI video input	10
3.2.2.	Using VGA input.....	11
3.3.	Connecting Audio Equipment	11
3.4.	OSD menu operation	12
4.	Input Mode	15
4.1.	HDMI PC Mode	15
4.2.	HDMI video mode.....	15
4.3.	VGA Mode	16
5.	Cleaning and Troubleshooting.....	17
5.1.	Cleaning	17
5.1.1.	Caution When Using the Display.....	17
5.1.2.	Front Panel Cleaning Instructions	17
5.1.3.	Cabinet Cleaning Instructions	17
5.2.	Troubleshooting	18
6.	Specification.....	19
6.1.	DS-D5043UC	19
6.2.	DS-D5055UC	19
6.3.	DS-D5065UC	20

1. Safety instructions

Pixel feature

This liquid crystal display product has ultrahigh color resolution. While its effective pixels are up to 99.999% or higher, it is still possible that a dark spot or a bright spot (red, green or blue) constantly appears on the screen. This is the structure property (within the general industrial standard) of the display rather than a fault.

The monitor will appear picture crash then reboot if influenced by strong electrostatic interference, it may self-recovered or need manual recovered to original status.

Safety

Please read and understand all instructions before using the monitor safety. Damage resulting from nonobservance of the instructions is not covered by the warranty.

Be careful of electric shock and fire!

- Never make the monitor contact with rain or water. Never place a liquid container (e.g., a vase) near or on the monitor. Please disconnect the monitor's power immediately if a liquid is spilled on the monitor's surface or inside. Please contact the customer service center before using it again.
- Never put a monitor, remote controller, or battery near an open flame or other heat source (including direct sunlight). In order to avoid flame spread, always keep candles or other open flames away from monitors, remote controls, and batteries.



- Never insert any object into the ventilation slot or other openings on the monitor.
- Please make sure that the power line is not taut. The tightening of the power line will loose the power connections and produce sparks.

Beware of short circuit or fire!

- Do not expose the remote controller or battery in rain, water or overheated environment.
- Please avoid pulling the plug. Loose power plugs may spark or cause fire.

Watch out for personal injury or monitor damage!

- It is suggested that the monitor be carried by two people.
 - When installing the monitor on the stand, please use only the chassis provided. Firmly fix the frame on the monitor. Put the monitor on a flat, flat surface that can withstand the total weight of the monitor and the chassis.
 - When installing a monitor with wall mounting, please use only the wall mount bracket that can bear the weight of the monitor. Fix the wall mount mounting bracket on the wall that can withstand the total weight of the monitor and the wall mount bracket.
- The company is not responsible for the accident, personal injury or loss caused by improper installation.

Be careful of hurting children!

Please follow the following precautions to avoid child injury due to monitor falling:

- Never place the monitor on a surface covered with a cloth or other material that can be pulled.
- Make sure that any part of the monitor is within the edge of the surface.
- When placing a monitor on a high furniture (such as a bookcase), the furniture and monitor must be fixed to the wall or the appropriate support.
- Tell children about the dangers of climbing furniture and touching monitors.

Beware of eating battery!

- The remote control of this product contains batteries. There is a risk that children might eat the batteries. Please keep them out of reach of children.

Watch out for overheating!

- Never install the monitor in the enclosed space. Always leave at least 4 inches or 10 centimeters of space around the monitor for ventilation. Make sure that curtains or other objects do not block the ventilation slot on the monitor.

Be careful! Don't break the monitor!

- Before you connect the monitor to the power outlet, make sure that the power voltage matches the value printed on the back of the monitor. If the voltage is different, don't connect the monitor to the power outlet.
- If the monitor is not used for a long time, please cut off the power supply.

Be careful of personal injury, fire or power line damage!

- Do not put the monitor or any object on the power line.
- As a disconnecting device, the power plug should be kept to operate conveniently.
- When the power line is disconnected, always hold the plug instead of pulling the cable.
- Before the thunderstorm comes, disconnect the monitor from the power outlet and the antenna. Never touch any part of a monitor, a power line, or an antenna in a thunderstorm.
- The wired network antenna connected to the equipment must be isolated from the protective grounding, otherwise it may cause fire and other dangers!

Watch out for hearing impairment!

- Avoid using headphones or earphones at high volume or for a long time.

Low temperature

- If the monitor is transported below 5° C, please open the package of the monitor. Wait for the monitor to adapt to the room temperature, and then connect the monitor to the power outlet.

1.1. Screen maintenance

Before using the monitor, please read and understand all the instructions. Damage resulting from nonobservance of the instructions is not covered by the warranty.

- Try to avoid still images. A still image means that an image stays on the screen for a long time. Still image may cause permanent damage to the monitor screen;
- the monitor screen to cause image blur, afterimage, local traces, and the display is not within the scope of warranty
- Don't display static images for more than 2 hours on the LCD monitor, because it will cause the screen image blur. In order to avoid this problem please reduce the brightness and contrast of the screen in the display of a still image.
- When you watch 4:3 programs for a long time, you leave different marks on the left and right sides of the screen and the edges of the image, so please don't use this mode for a long time.
- Image sticking may occur if playing video games or displaying still images for a long time. It is caused by screen burn. Please reduce brightness and contrast when appropriate.
- Pull out the monitor plug before cleaning.
- Use a soft dry cloth to wipe the monitor and frame. Do not use alcohol, chemicals or household cleaning agent cleaning monitor.
- Watch out for damage to monitor screen! Do not use any object to contact, push, rub or tap the screen.
- In order to avoid deformation and fading, please wipe water as soon as possible.

2. Parts and Functions

2.1. Button Description

2.1.1. DS-D5043UC

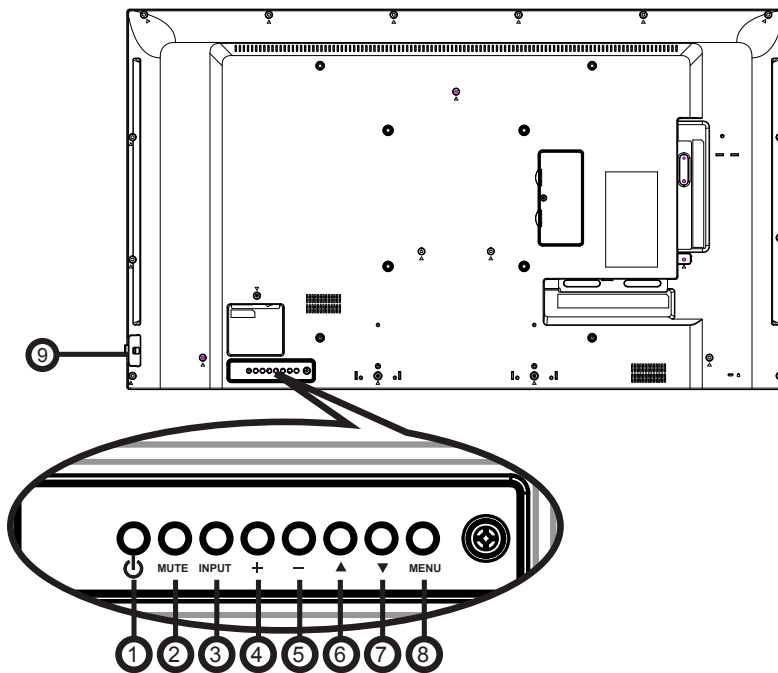

2.1.2. DS-D5055UC

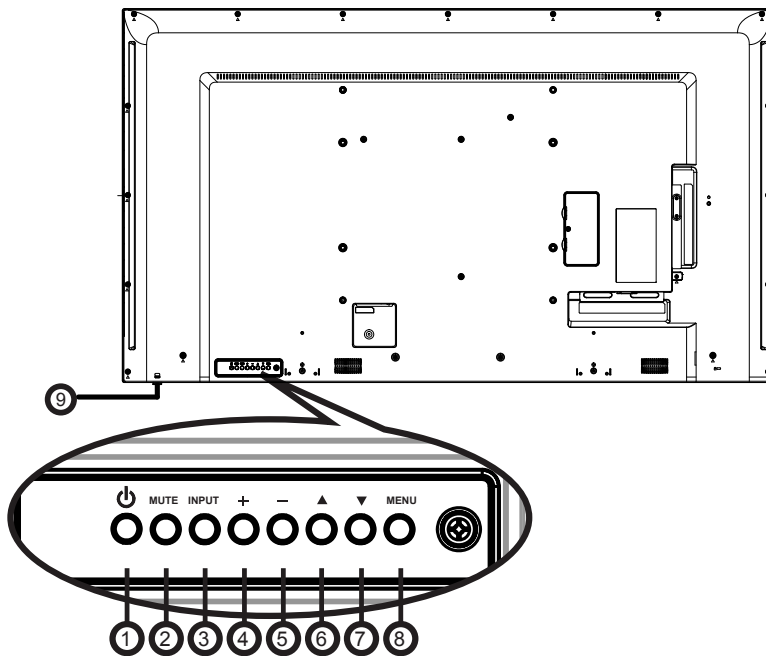

2.1.3. DS-D5065UC

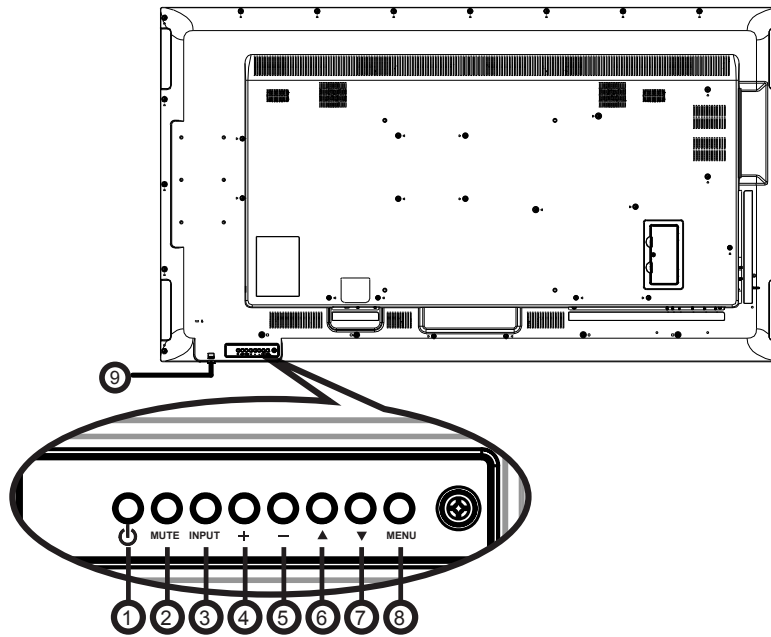

SN	Button	Description
①	[⏻] button	Turn on or turn off the display.
②	[MUTE] button	Switch the mute ON/OFF.
③	[INPUT] button	Choose the input source.
④	[+] button	When the OSD menu is on, this button increases the adjustment value.
⑤	[-] button	When the OSD menu is on, this button decreases the adjustment value.
⑥	[▲] button	When the OSD menu is on, scroll up the menu to adjust the selected item.
⑦	[▼] button	When the OSD menu is on, scroll down the menu to adjust the selected item.
⑧	[MENU] button	Return to previous menu while OSD menu is on, or to activate the OSD menu when OSD menu is off.
⑨	Remote sensor and power indicator	<ul style="list-style-type: none"> Use them to receive the command signal from the remote control. (Please pull out the lens for better reception.) Power indicator. The light is red during standby. The light is green after booting. The light flashes red when operating the controller.

2.2. Input/Output Terminals

2.2.1. DS-D5043UC

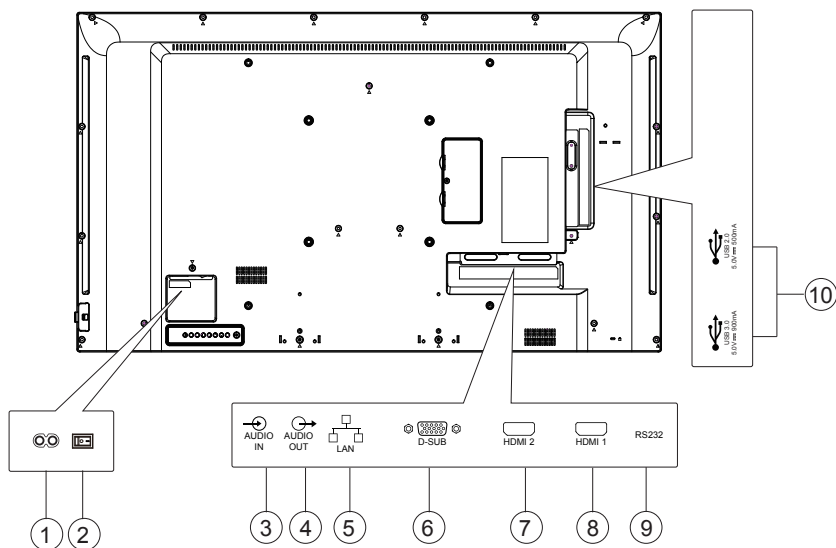

2.2.2. DS-D5055UC

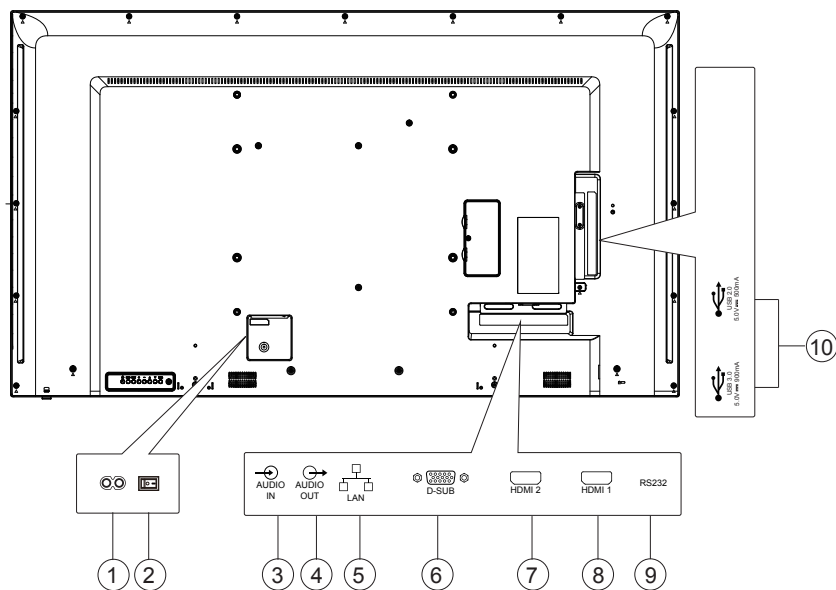

2.2.3. DS-D5065UC

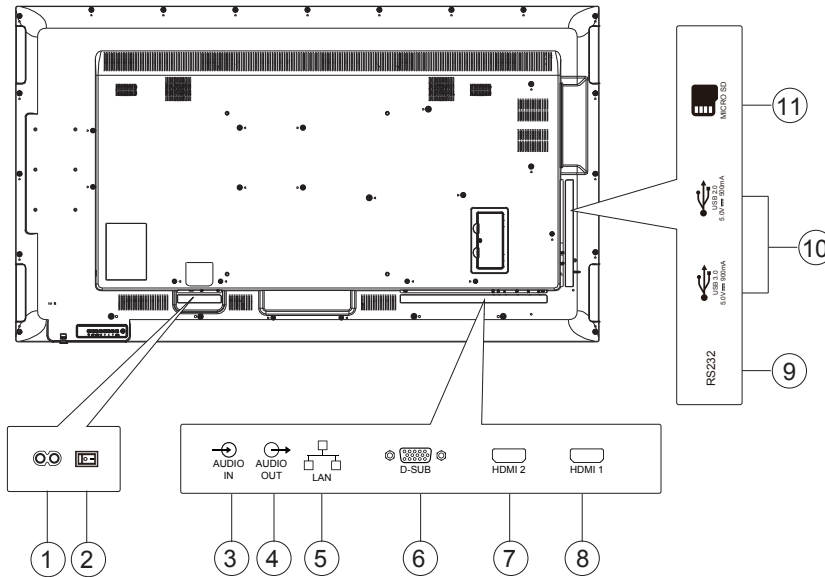

SN	Port	Description
①	AC IN	AC power input from the wall outlet.
②	MAIN POWER SWITCH	Switch the main power on/off.
③	AUDIO IN	Used for the audio input signal of plug-in video/audio device.
④	AUDIO OUT	Simulate the audio output.
⑤	LAN	LAN connection. (Not available when leaving the factory)
⑥	D-SUB input	VGA video input.
⑦	HDMI 2	HDMI 2 video/audio input.
⑧	HDMI 1	HDMI 1 video/audio input.
⑨	RS232	Provide RS232 external control. (Not available when leaving the factory)
⑩	USB port	Connect your USB storage device. (USB 2.0 cannot be used after leaving the factory. USB 3.0 is used for system software update)
⑪	MICRO SD	Connect your MICRO SD CARD. Extension to 32GB is supported. (Not available when leaving the factory)

2.3. Remote control

2.3.1. General function

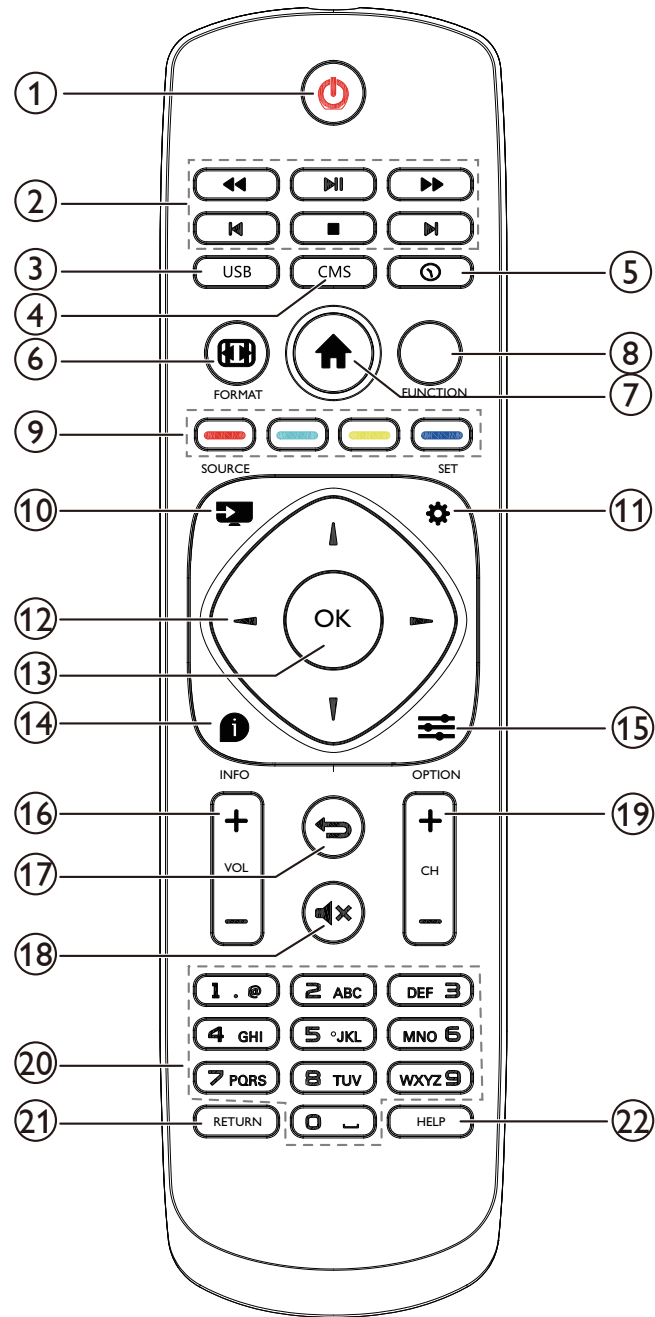

- ① Power button
Press this button to enter the power save mode.
Press and hold this button for 5 seconds to enter the standby mode and press this button for booting.
- ② [Play] button
Control playing of media document. (Not available when leaving the factory)
- ③ USB
Enter the USB drive. (Not available when leaving the factory)

- ④ CMS
Enter the CMS app. (Not available when leaving the factory)
- ⑤ Time
Time setting.
- ⑥ Aspect ratio
No function.
- ⑦ [Home] button
Visit the main interface of Android. (Not available when leaving the factory)
- ⑧ Function list
No function.
- ⑨ [Red] [Green] [Yellow] [Blue] Color button
No function.
- ⑩ Source signal
Press the button to display the source signal list.
- ⑪ Settings
Visit the OSD menu.
- ⑫ [Up] [Down] [Left] [Right] Navigation button
Navigate and select items in the menu.
- ⑬ OK
Confirm the input or selection.
- ⑭ Information
Display the information on current events.
- ⑮ Application menu
Visit the options available, such as media and PDF players.
- ⑯ [+] [-] Volume button
Increase and decrease volume.
Visit the option, screen and volume menus available.
- ⑰ [Return] button
Return or exit the application on the menu.
- ⑱ [Mute] button
Press this button to turn the mute function on and off.
- ⑲ [+] [-] Channel button
No function.
- ⑳ [Number] key
Enter the network setup text. (Not available when leaving the factory)
- ㉑ Playback
No function.
- ㉒ Help
No function.

2.3.2. Inserting the batteries in the remote control

The remote control is powered by two 1.5V AAA batteries. To install or replace batteries:

1. Press and then slide the cover to open it.
2. Align the batteries according to the (+) and (-) indications inside the battery compartment.
3. Replace the cover.

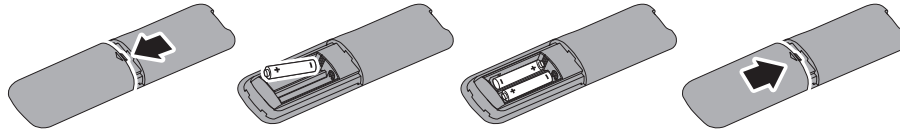

Caution:

The incorrect use of batteries can result in leaks or bursting. Be sure to follow these instructions:

- Place “AAA” batteries matching the (+) and (-) signs on each battery to the (+) and (-) signs of the battery compartment.
- Do not mix battery types.
- Do not combine new batteries with used ones. It causes shorter life or leakage of batteries.
- Remove the dead batteries immediately to prevent them from liquid leaking in the battery compartment. Don't touch exposed battery acid, as it can damage your skin.

NOTE: If you do not intend to use the remote control for a long period, remove the batteries.

2.3.3. Handling the remote control

- Do not subject to strong shock.
- Do not allow water or other liquid to splash the remote control. If the remote control gets wet, wipe it dry immediately.
- Avoid exposure to heat and steam.
- Other than to install the batteries, do not open the remote control.

2.3.4. Remote control use

When using a remote control, press it close to the monitor, and point to the remote sensor. Ensure that the sight between the remote control and the monitor is not obstructed by furniture, walls, or other objects.

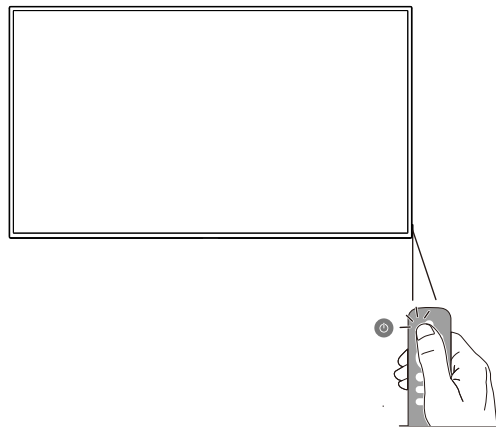

3. Connecting External Equipment

 **Note:** The following illustration for the rear case of the monitor connecting to an external device is for reference only. Actual products may vary.

3.1. Connecting External Equipment

3.1.1. Using HDMI video input

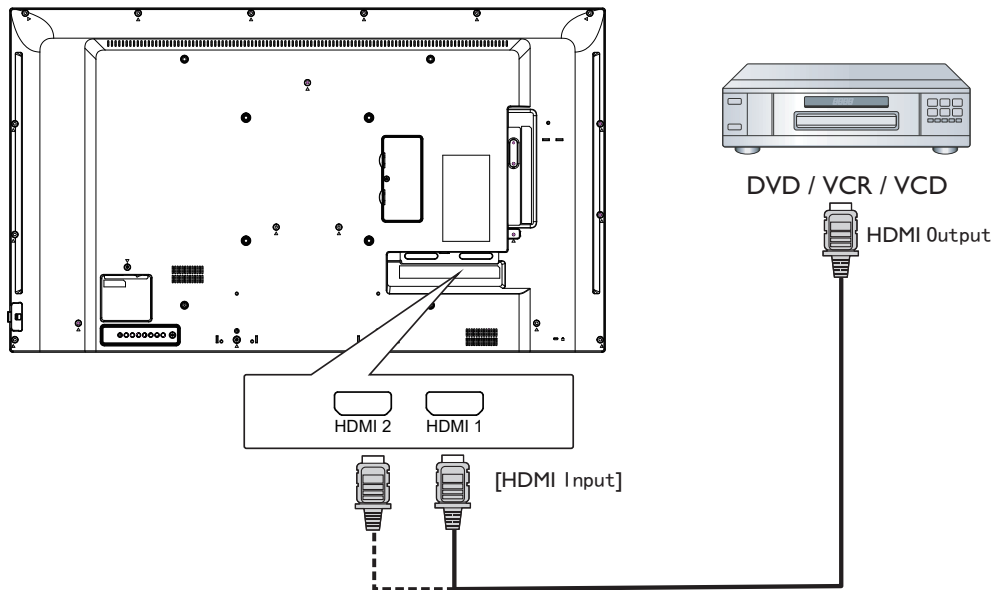

3.2. Connecting a PC

3.2.1. Using HDMI video input

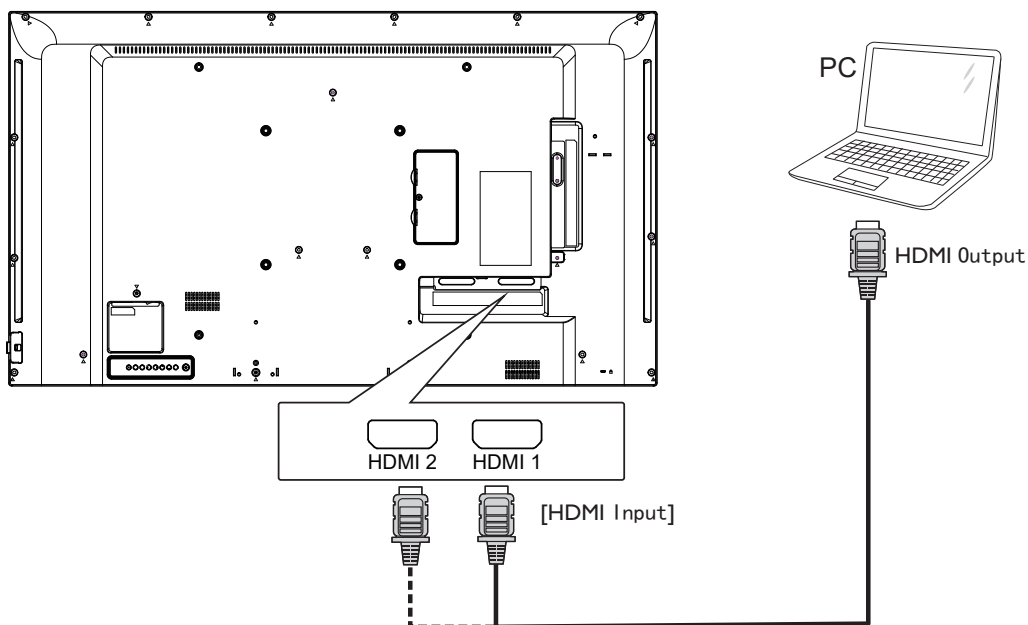

3.2.2. Using VGA input

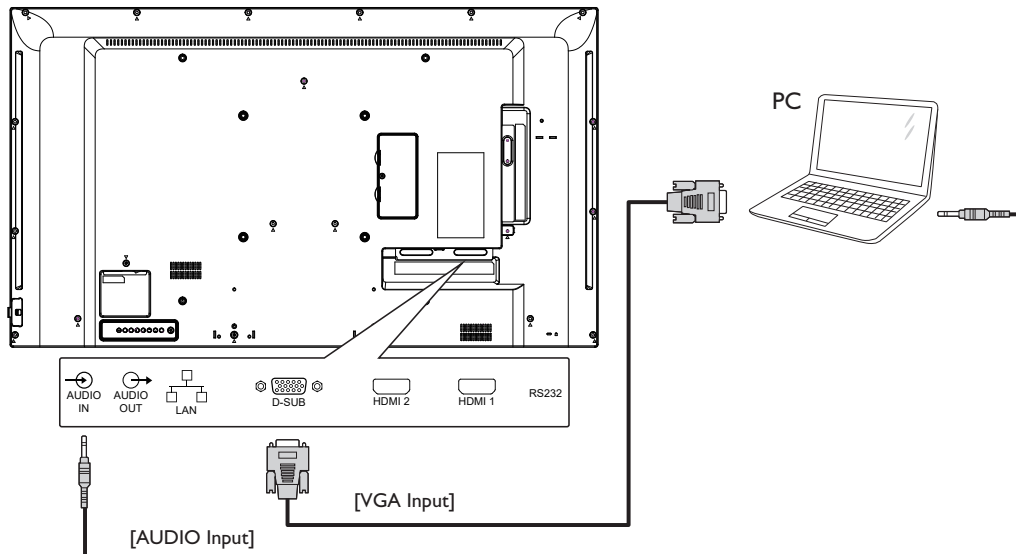

3.3. Connecting Audio Equipment

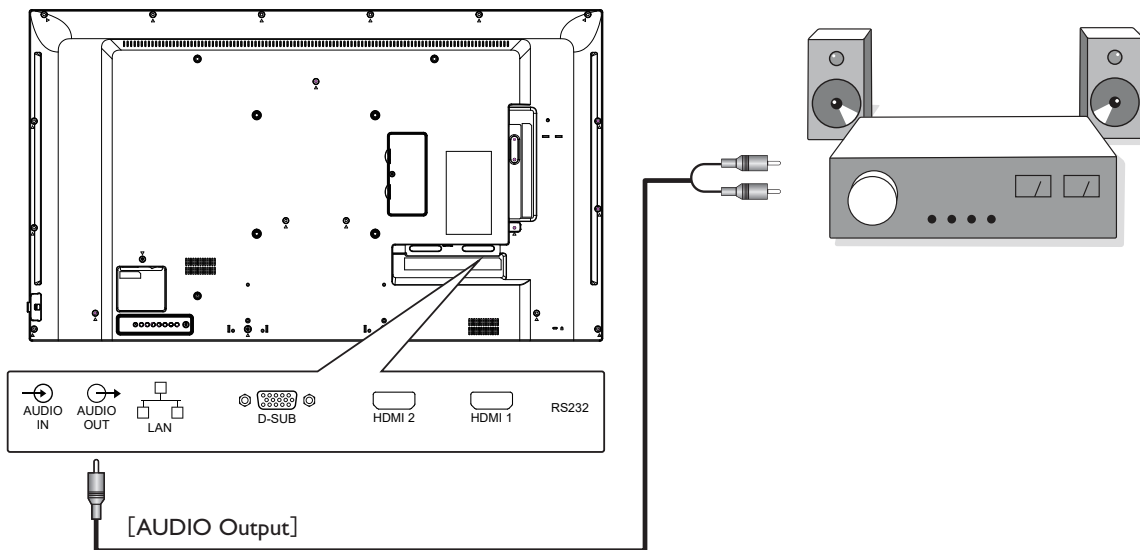

3.4. OSD menu operation

Column 1	Column 2	Column 3 of 1	Column 3 of 2 or Column 2 of 2	Remark
Picture	Picture Mode	Mode	Airport and train station	
			Hotel and convenient store	
			Dining and clothing	
			Security control and monitoring	
			Office	
			Outdoor	
			Customize	
		Brightness	[0 ... 100]	
		Contrast	[0 ... 100]	
	Backlight	[0 ... 100]		
	Dynamic Backlight	On/Off	Dynamic backlight is only functional under HDMI1/2.	
	Advanced	VGA	Auto Adjust	
			Horizontal [0...100]	
			Vertical [0...100]	
			Clock [0...100]	
			Phase [0...100]	
		Color temp	Standard (9300K)	
			Cool (12000K)	
			Warm (6500K)	
		Over scan	On/Off	It depends on if it is PC or video mode.
RGB Range		Auto		
		Full Range		
	Limited Range			
	PC Mode			
PC Mode	PC / Video / Auto	You can use this function to change the PC or video mode.		
Screen Orientation	Screen Orientation	0,90,180,270		
Sound	Sound Mode	Standard		
		News		
		Music		
		Movie		
	Audio Source	HDMI	This option is only available under HDMI Source.	
		Line in		
Advanced	Balance	[-50 ... +50]		
	Volume	[0 ... 100]		
Lock	Key Lock	Off	Default password: 0000 The button lock is changed to On: Step 1: The remote control, button and mouse are locked 5 seconds after this button has not been operated. Step 2: After the function is locked, you must press the settings button on the remote control. After operation, enter the correct password in the password prompt dialog to unlock the function. Step 3: After configuration, repeat Step 1. Note: The power button of the machine is locked.	
		[type password]		
	Change Password	Current Password		
		New Password		
		Confirm Password		
Cancel/OK				

Time	Time Setup	Time Setting	Date Picker	Set the month, day, year, hour and minute.
		Shutdown Time	Repeat	OFF/Once/Everyday/Workday
			Time	Set the time.
		Power Time	Repeat	OFF/Once/Everyday/Workday
			Time	Set the time.
			Source	VGA/HDMI1/HDMI2
		Sleep Time	File Number [1 ... 7]	It depends on the source (= MEDIA/PDF).
			OFF/10 minutes/20 minutes/30 minutes/60 minutes/90 minutes/120 minutes/180 minutes/240 minutes	
Auto Sleep	Off/5 seconds/10 seconds/30 seconds/60 seconds			
Time Sync	network Time/OFF			
Time Zone	Beijing/Calcutta/Harare/Karachi/Brazzaville/Beirut/Jerusalem/Tehran/Baghdad/Ulaanbaatar/Damascus/Sydney/Paris/Rome/London/Dubai/Tokyo			
Advanced	Language	English		
		Chinese		
	HDMI Version	HDMI1.4		Sound might mute when switching the HDMI version. Please unplug the HDMI cable or shutdown the monitor to solve the problem.
		HDMI2.0		
	Power On Mode	Power On		
		Standby		
		Last Status		
	Boot On Source	Switch	On/Off	If the turn off time has been set on the schedule but it is not the time for booting yet, booting is executed based on the signal source set for "Boot On Source" .
		Source	VGA/HDMI1/HDMI2	
		Play List	Playlist [1 ... 7]	
	Boot Wake	UART Wake	On/Off	If UART wake = On, RC off or power saving, you can wake up the UART by UART wake.
		HDMI/VGA Wake	On/Off	When HDMI/VGA wake = On, the current source is HDMI1/2 or VGA. You can only wake up the HDMI/VGA when in power saving mode and there is a signal for the current HDMI 1/2 or VGA source.
	RS232 Control	On/Off		
Pixel Shift	On/Off			
Uplayer Setting	Switch	On/Off	1. When Uplayer Setting is On, Boot On Source is in grayscale and it is invalid. 2. The name of the supported folder: SuperU 3. To play the content in U Player, the system switches the source to USB and sticks to USB Source when unplugging the USB drive. 4. When booting, the system skips to U Player. The priority level is higher than the signal source specified for SCH booting.	
	Repeat Time	8 seconds/16 seconds/24 seconds/32 seconds	The document formats supported are: 1. Image: ".png", ".jpg" 2. Video: ".dat", ".vob", ".ts", ".mkv", ".mov", ".3gp", ".flv", ".webm", ".wmv", ".asf", ".mp4", ".avi", ".mpg".	

Advanced	Restore	Restore Default	Cancel/OK	System reset
----------	---------	-----------------	-----------	--------------



Note: To wake PD from the HDMI source, you can set HDMI wake to ON.

This product supports auto shutdown and auto turn on. Refer to “Shutdown\boot time” in the table above for details.

4. Input Mode

4.1. HDMI PC Mode

Standard Resolution	Active Resolution		Refresh Rate	Pixel Rate	Aspect Ratio
	H Pixels	V Lines			
VGA	640	480	60 Hz	25.175 MHz	4:3
			75 Hz	31.5 MHz	
WVGA	720	400	70 Hz	28.32 MHz	4:3
SVGA	800	600	60 Hz	40 MHz	4:3
XGA	1024	768	60 Hz	65 MHz	4:3
WXGA	1152	870	75 Hz	100 MHz	4:3
WXGA	1280	720	60 Hz	74.5 MHz	5:3
SXGA	1280	1024	60 Hz	108 MHz	5:4
UXGA	1600	900	60 Hz	108 MHz	4:3
UXGA	1680	1050	60 Hz	146.25 MHz	16:10
HD1080	1920	1080	60 Hz	148.5 MHz	16:9

Recommended resolution: 3840*2160@60Hz

4.2. HDMI video mode

Standard Resolution	Active Resolution		Refresh Rate	Pixel Rate	Aspect Ratio
	H Pixels	V Lines			
3840 x 2160 P 60 Hz	3840	2160	60 Hz	594 MHz	16:9
3840 x 2160 P 30 Hz	3840	2160	30 Hz	297 MHz	16:9
3840 x 2160 P 25 Hz	3840	2160	25 Hz	297 MHz	16:9
3840 x 2160 P 24 Hz	3840	2160	24 Hz	297 MHz	16:9
1080 P 59.94/60 Hz	1920	1080	60 Hz	148.5 MHz	16:9
1080 P 50 Hz	1920	1080	50 Hz	148.5 MHz	16:9
1080 P 29.97/30 Hz	1920	1080	30 Hz	74.25 MHz	16:9
1080 P 25 Hz	1920	1080	25 Hz	74.25 MHz	16:9
1080 P 23.97/24 Hz	1920	1080	24 Hz	74.25 MHz	16:9
1080 I 59.94/60 Hz	1920	1080	60 Hz	74.25 MHz	16:9
1080 I 50 Hz 16:9	1920	1080	50 Hz	74.25 MHz	16:9
720 P 50 Hz 16:9	1280	720	50 Hz	74.25 MHz	16:9
720 P 59.94/60 Hz	1280	720	60 Hz	74.25 MHz	16:9
576 I 50 Hz 4:3	720	576	50 Hz	13.5 MHz	4:3
576 I 50 Hz 16:9	720	576	50 Hz	13.5 MHz	16:9
480 I 59.94/60 Hz	720	480	60 Hz	13.5 MHz	4:3
576 P 50 Hz 4:3	720	576	50 Hz	27 MHz	4:3
576 P 50 Hz 16:9	720	576	50 Hz	27 MHz	16:9
480 P 59.94/60 Hz	720	480	60 Hz	27 MHz	16:9
480 P 59.94/60 Hz	720	480	60 Hz	27 MHz	4:3

4.3. VGA Mode

Standard Resolution	Available Resolution		Refresh Rate	Pixel Rate	Aspect Ratio
	Horizontal Rate	Vertical Rate			
VGA	640	480	60 Hz	25.175 MHz	4:3
			75 Hz	31.5 MHz	
WVGA	720	400	70 Hz	28.32 MHz	4:3
SVGA	800	600	60 Hz	40 MHz	4:3
XGA	1024	768	60 Hz	65 MHz	4:3
WXGA	1152	870	75 Hz	100 MHz	4:3
WXGA	1280	720	60 Hz	74.5 MHz	5:3
SXGA	1280	1024	60 Hz	108 MHz	5:4
UXGA	1600	900	60 Hz	108 MHz	4:3
UXGA	1680	1050	60 Hz	146.25 MHz	16:10
HD1080	1920	1080	60 Hz	148.5 MHz	16:9
WXGA	1366	768	60 Hz	85.75 MHz	16:9

5. Cleaning and Troubleshooting

5.1. Cleaning

5.1.1. Caution When Using the Display

- Do not bring your hands, face or objects close to the ventilation holes of the display. The top of the display is usually very hot due to the high temperature of exhaust air being released through the ventilation holes. Burns or personal injuries may occur if any body parts are brought too close. Placing any object near the top of the display could also result in heat related damage to the object as well as the display itself.
- Be sure to disconnect all cables before moving the display. Moving the display with its cables attached may damage the cables and thus cause fire or electric shock.
- Disconnect the power plug from the wall outlet as a safety precaution before carrying out any type of cleaning or maintenance procedure.

5.1.2. Front Panel Cleaning Instructions

- The front of the display has been specially treated. Wipe the surface gently using only a cleaning cloth or a soft, lint-free cloth.
- If the surface becomes dirty, soak a soft, lint-free cloth in a mild detergent solution. Wring the cloth to remove excess liquid. Wipe the surface of the display to remove dirt. Then use a dry cloth of the same type to dry.
- Do not scratch or hit the surface of the panel with fingers or hard objects of any kind.
- Do not use volatile substances such as insert sprays, solvents and thinners.

5.1.3. Cabinet Cleaning Instructions

- If the cabinet becomes dirty, wipe the cabinet with a soft, dry cloth.
- If the cabinet is extremely dirty, soak a lint-free cloth in a mild detergent solution. Wring the cloth to remove as much moisture as possible. Wipe the cabinet. Use another dry cloth to wipe over until the surface is dry.
- Do not allow any water or detergent to come into contact with the surface of the display. If water or moisture gets inside the unit, operating problems, electrical and shock hazards may result.
- Do not scratch or hit the cabinet with fingers or hard objects of any kind.
- Do not use volatile substances such as insert sprays, solvents and thinners on the cabinet.
- Do not place anything made from rubber or PVC near the cabinet for any extended periods of time.

5.2. Troubleshooting

Symptom	Possible Cause	Remedy
No picture is displayed	<ol style="list-style-type: none"> 1. The power cord is disconnected. 2. The main power switch on the back of the display is not switched on. 3. The selected input has no connection. 4. The display is in standby mode. 	<ol style="list-style-type: none"> 1. Plug in the power cord. 2. Make sure the power switch is switched on. 3. Connect a signal connection to the display.
Interference displayed on the display or audible noise is heard	Caused by surrounding electrical appliances or fluorescent lights.	Move the display to another location to see if the interference is reduced.
Color is abnormal	The signal cable is not connected properly.	Make sure that the signal cable is attached firmly to the back of the display.
Picture is distorted with abnormal patterns	<ol style="list-style-type: none"> 1. The signal cable is not connected properly. 2. The input signal is beyond the capabilities of the display. 	<ol style="list-style-type: none"> 1. Make sure that the signal cable is attached firmly. 2. Check the video signal source to see if it is beyond the range of the display. Please verify its specifications with this display's specification section.
Can hear sound, but no picture	Improperly connected source signal cable.	Make sure that both video inputs and sound inputs are correctly connected.
Can see picture but no sound is heard	<ol style="list-style-type: none"> 1. Improperly connected source signal cable. 2. Volume is turned all the way down. 3. {Mute} is turned on. 4. No external speaker connected. 	<ol style="list-style-type: none"> 1. Make sure that both video inputs and sound inputs are correctly connected. 2. Press [+] or [-] button to hear sound. 3. Switch MUTE off by using the [] button. 4. Connect external speakers and adjust the volume to a suitable level.
Some picture elements do not light up	Some pixels of the display may not turn on.	This display is manufactured using an extremely high level of precision technology; however, sometimes some pixels of the display may not display. This is not a malfunction.
After-Images can still be seen on the display after the display is powered off. (Examples of still pictures include logos, video games, computer images, and images displayed in 4:3 normal mode)	A still picture is displayed for an over extended period of time	Do not allow a still image to be displayed for an extended period of time as this can cause a permanent after-image to remain on the display.
The display has horizontal or vertical interference		Enter VGA setting which under picture option of OSD MENU to do auto adjust or adjust frequency / phase.
Image deviation from the center of the display or size error		Enter VGA setting which under picture option of OSD MENU to do auto adjust then adjust horizontal /vertical position if needed.

6. Specification

6.1. DS-D5043UC

LCD panel	Drive system	43 Inch TFT color LCD
	Dimension	108 cm diagonal line
	Pixel distance	0.2451mm(H) × 0.2451mm(V)
Input	Video signal	Digital/analog
	Horizontal frequency	30kHz - 83kHz
	Vertical frequency	56 - 75Hz
Display color		1.07billion
Maximum resolution		3840 x 2160@60Hz
Power consumption	Standby power consumption (standby)	< 0.5W
	Shutdown power consumption (shutdown)	< 0.5W
	Startup power consumption	120W (max.) 90W (typical)
Input joint		15-pin D-Sub, 19-pin HDMI
Input video		Digital/analog
Maximum display dimension		Horizontal: 941.184 mm Vertical: 529.416 mm
Power Supply		100-240 VAC, 50/60Hz
Operating environmental conditions		Operating temperature: 0° to 40°C Storage temperature: -20° to 60°C Operating humidity: 20% to 80% Storage humidity: 10% to 90%
Dimension (W x H x D)		Without base: 968.2(W) x 559(H) x 60.9(D) mm
Weight (net weight)		8.6kg

6.2. DS-D5055UC

LCD panel	Drive system	55 Inch TFT color LCD
	Dimension	139 cm diagonal line
	Pixel distance	0.315mm(H) × 0.315mm(V)
Input	Video signal	Digital/analog
	Horizontal frequency	30kHz - 83kHz
	Vertical frequency	56 - 75Hz
Display color		1.07billion
Maximum resolution		3840 x 2160@60Hz
Power consumption	Standby power consumption (standby)	< 0.5W
	Shutdown power consumption (shutdown)	< 0.5W
	Startup power consumption	180W (max.) 155W (typical)
Input joint		15-pin D-Sub, 19-pin HDMI
Input video		Digital/analog
Maximum display dimension		Horizontal: 1209.6 mm Vertical: 680.4 mm
Power Supply		100-240 VAC, 50/60Hz
Operating environmental conditions		Operating temperature: 0° to 40°C Storage temperature: -20° to 60°C Operating humidity: 20% to 80% Storage humidity: 10% to 90%
Dimension (W x H x D)		Without base: 1239.2(W) x 711.6(H) x 61.7(D) mm
Weight (net weight)		16kg

6.3. DS-D5065UC

LCD panel	Drive system	65 Inch TFT color LCD
	Dimension	164 cm diagonal line
	Pixel distance	0.372mm(H) × 0.372mm(V)
Input	Video signal	Digital/analog
	Horizontal frequency	30kHz - 83kHz
	Vertical frequency	56 - 75Hz
Display color		1.07billion
Maximum resolution		3840 x 2160@60Hz
Power consumption	Standby power consumption (standby)	< 0.5W
	Shutdown power consumption (shutdown)	< 0.5W
	Startup power consumption	270W (max.)
170W (typical)		
Input joint		15-pin D-Sub, 19-pin HDMI
Input video		Digital/analog
Maximum display dimension		Horizontal: 1428.48 mm Vertical: 803.52 mm
Power Supply		100-240 VAC, 50/60Hz
Operating environmental conditions		Operating temperature: 0° to 40°C Storage temperature: -20° to 60°C Operating humidity: 20% to 80% Storage humidity: 10% to 90%
Dimension (W x H x D)		Without base: 1458.7(W) x 834.7(H) x 81.6(D) mm
Weight (net weight)		24.5kg



See Far, Go Further